



Thank you for choosing yet another Ninjatoes' paper model from <http://members.lycos.nl/ninjatoes/index.html>. this time it's the U.S.S. Defiant from "Star Trek Deep Space Nine". Built originally to answer the Borg threat, this tough little ship is the Federation's first true warship, This also made it ideal to fight off the Jem' Hadar at DS9, as Captain Benjamin Sisco pointed out....;o)

Scale of this model is approximately 1/500, when printed "fit to page" (which should be about 187%). Have fun building, and don't forget to tell me what you think of it at ninjatoes@lycos.nl!

greetz ninjatoes

U.S.S. DEFIANT NX-74205

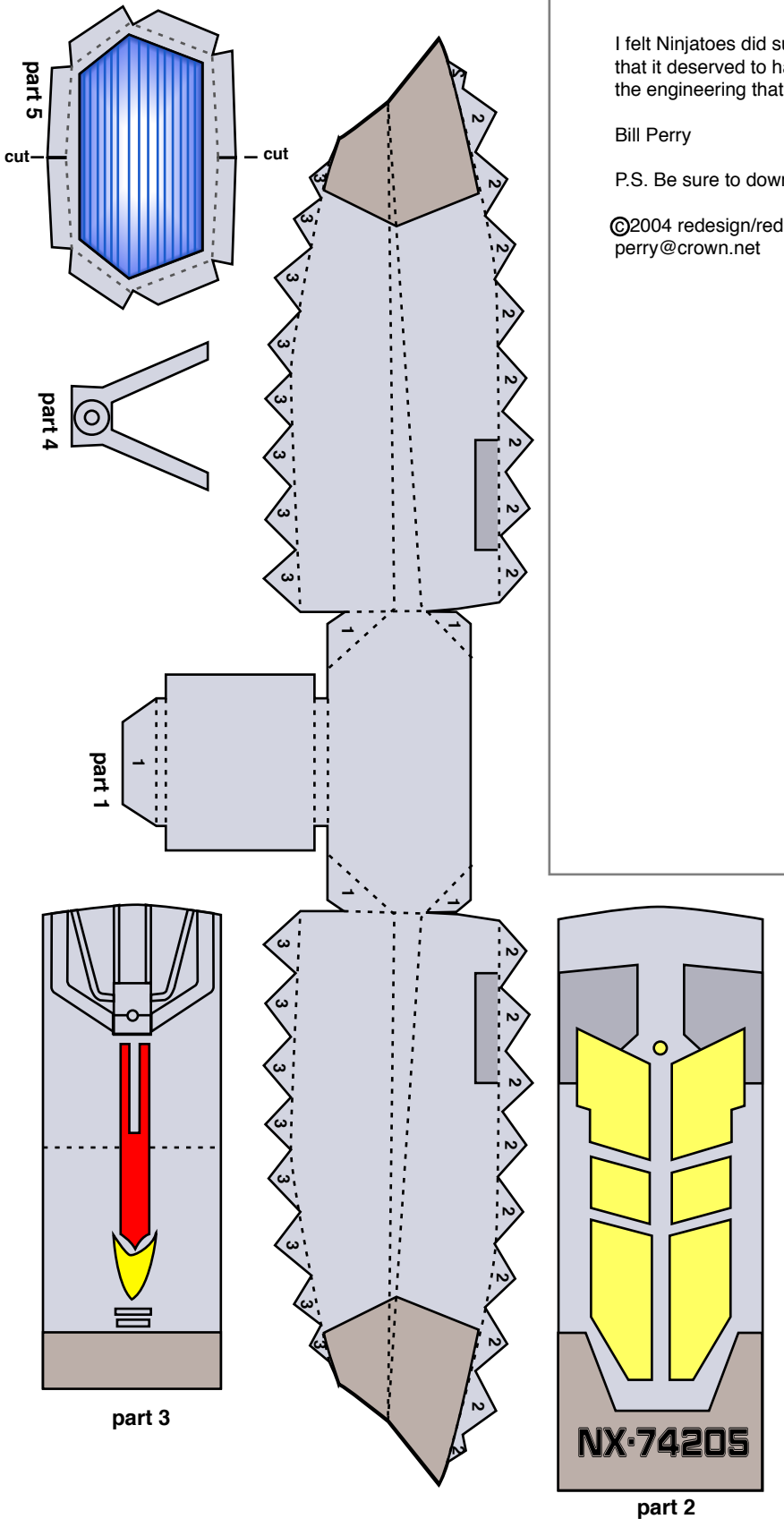

I felt Ninjatoes did such a fine job designing this model, that it deserved to have a graphicstreatment worthy of the engineering that went into it. Enjoy!

Bill Perry

P.S. Be sure to download the assembly directions, it will save you time.

©2004 redesign/redraw/assembly directions by Bill Perry
perry@crown.net

part 6a

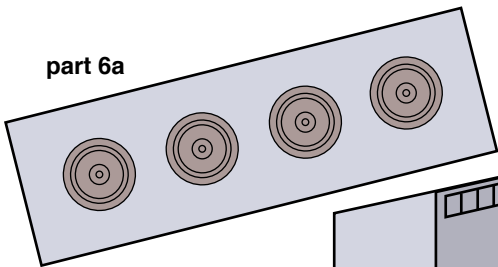

part 7

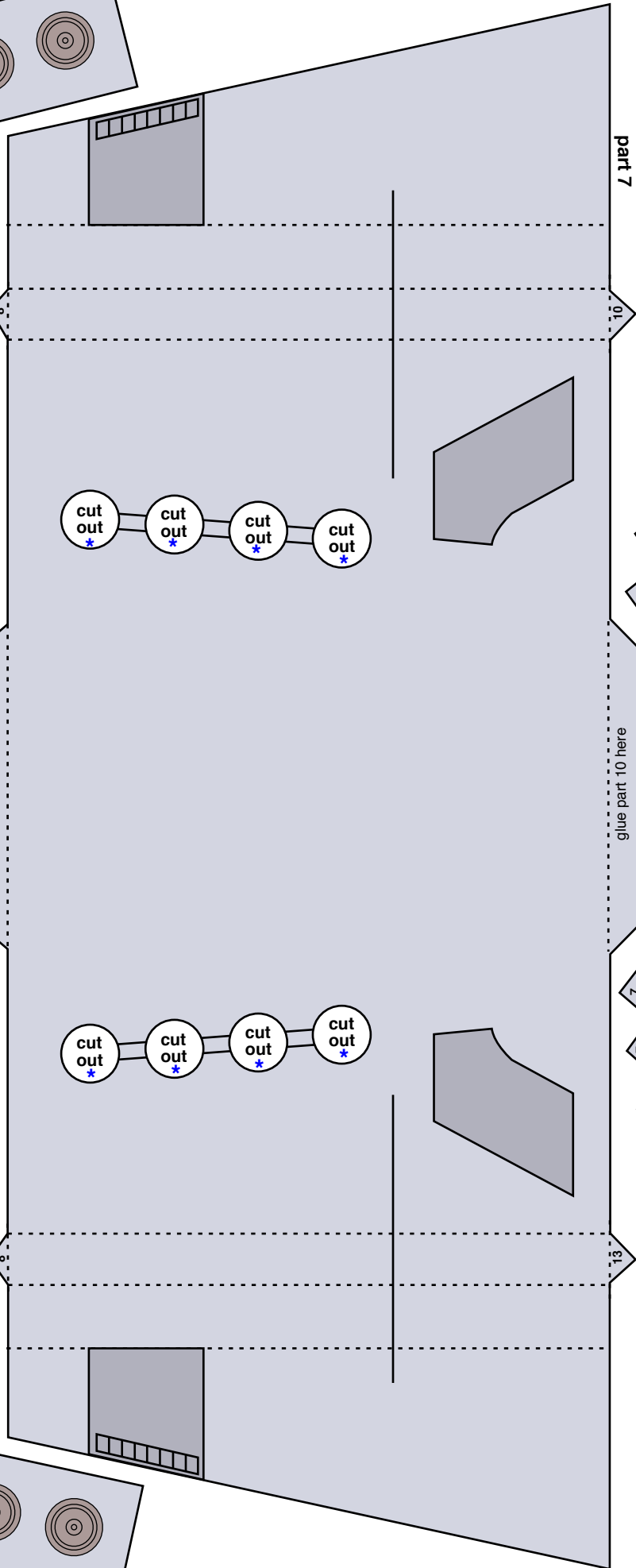

part 9a

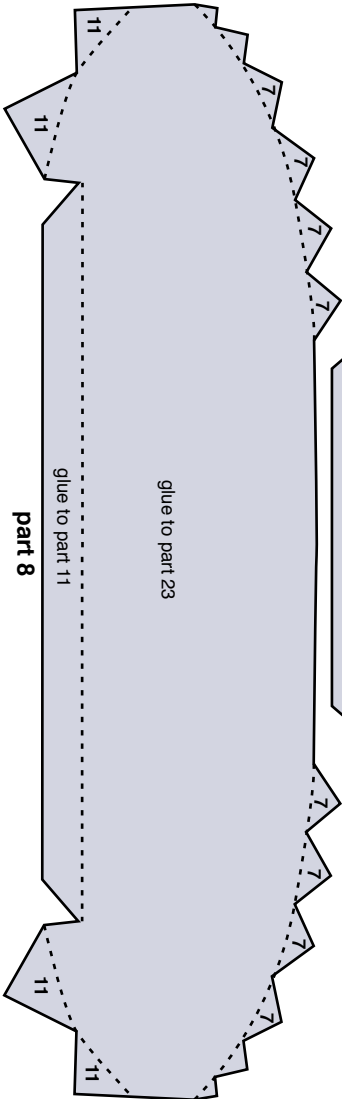

part 8

glue to part 11

glue to part 23

glue part 8 here

glue part 10 here

glue part 12 here

glue to part 1

part 10

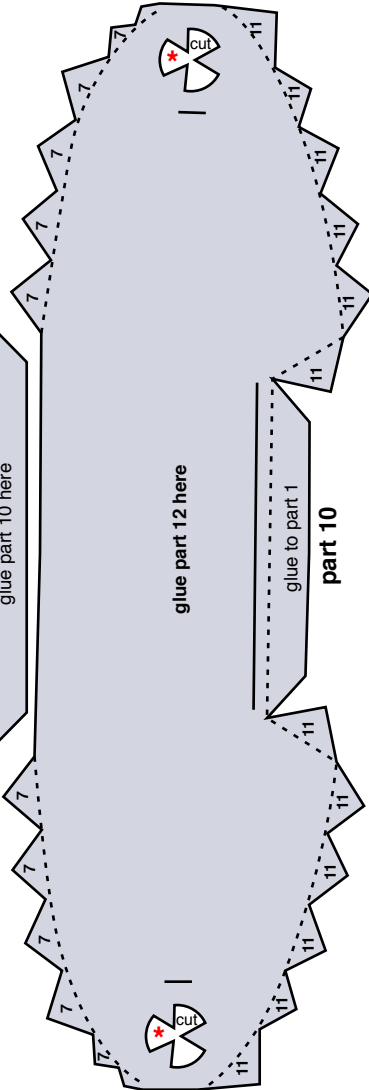

part 9b

* glue parts 6a/b here

* glue parts 9a/b here

part 6b

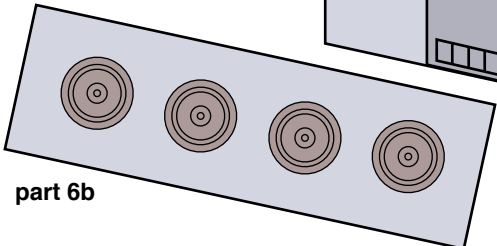

part 11

glue to part 26

glue parts 31-35 here

cut out

★ glue part 10 here

glue to part 7

glue to part 7

part 10

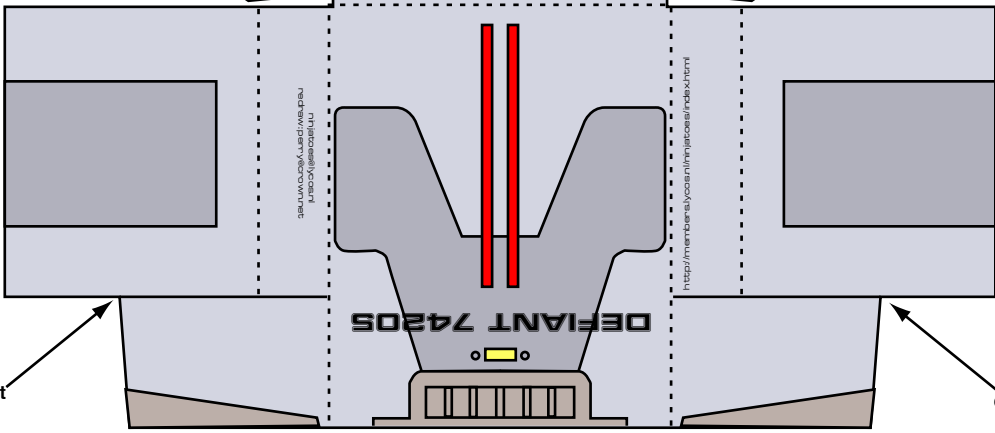
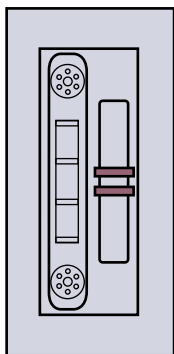

cut

cut

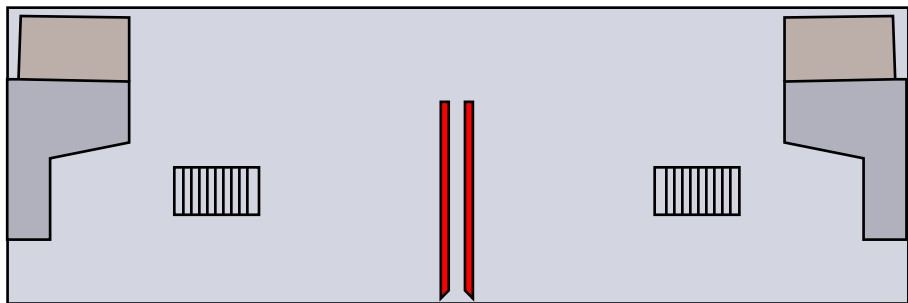

part 13

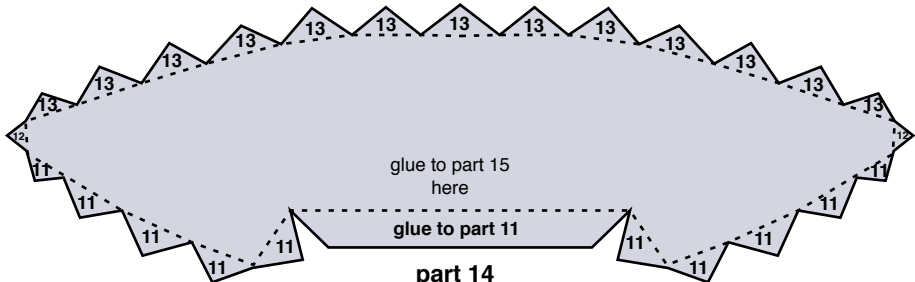

glue to part 15 here

glue to part 11

part 14

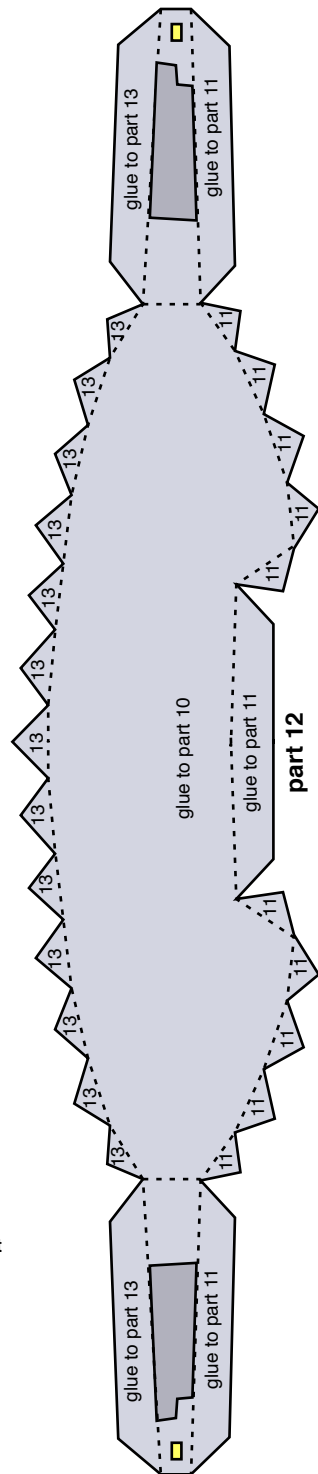

glue to part 13

glue to part 11

glue to part 10

glue to part 11

part 12

glue to part 13

glue to part 11

part 15

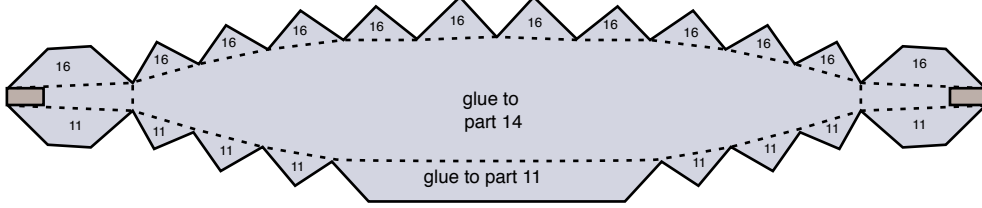

part 21b

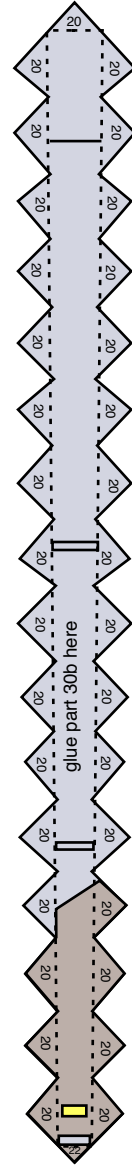

part 21a

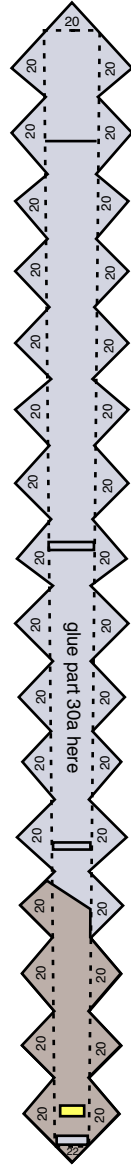

part 16

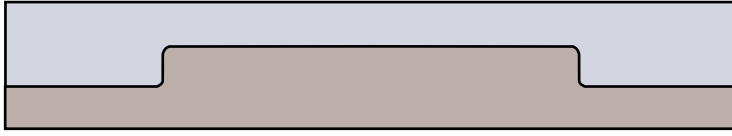

part 17

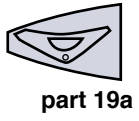
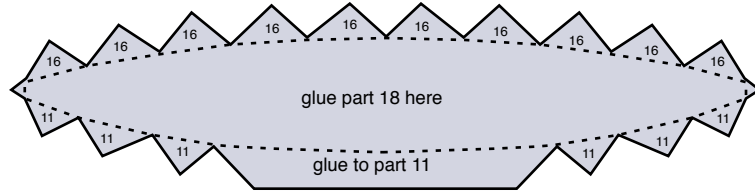

part 19a

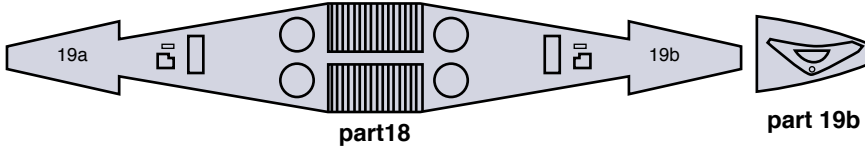

part 18

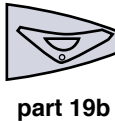

part 19b

part 22

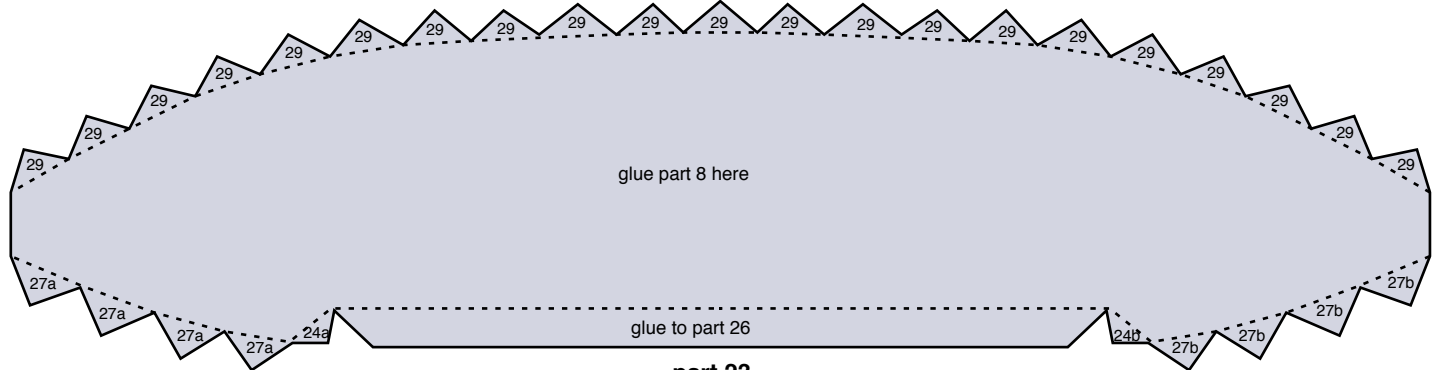
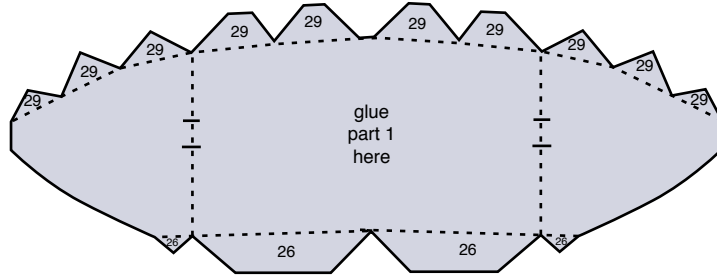

part 23

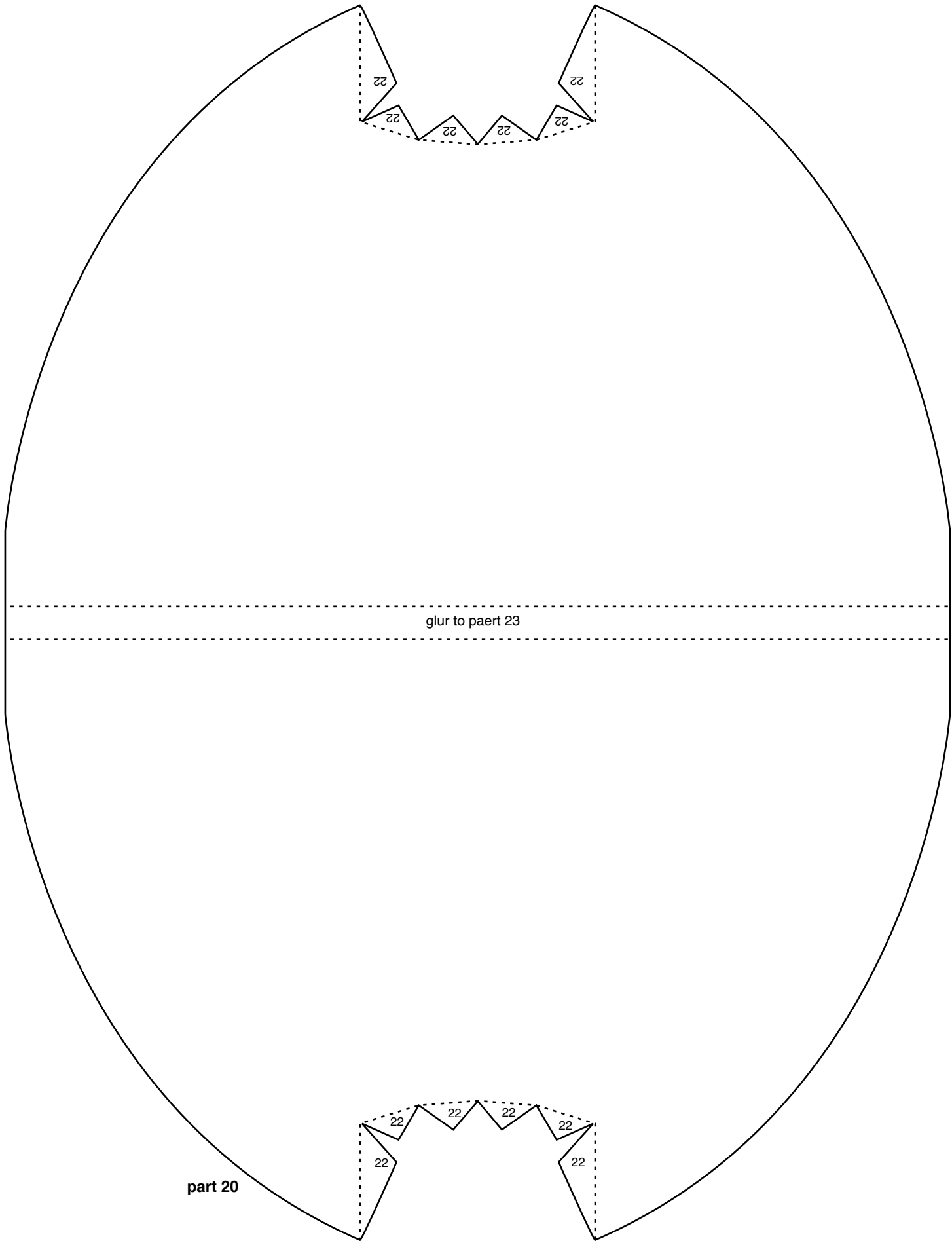

22

22

22

22

22

22

glur to paert 23

part 20

22

22

22

22

22

22

part 24a

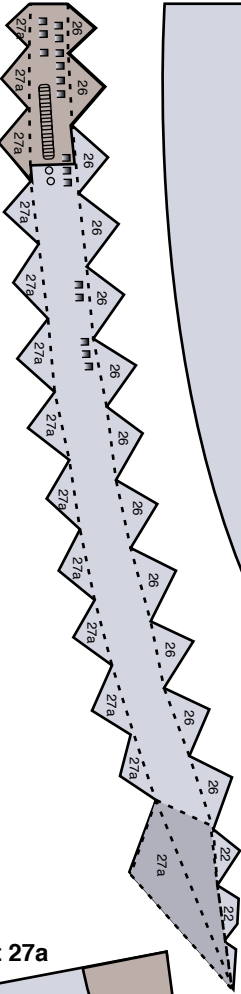

part 26

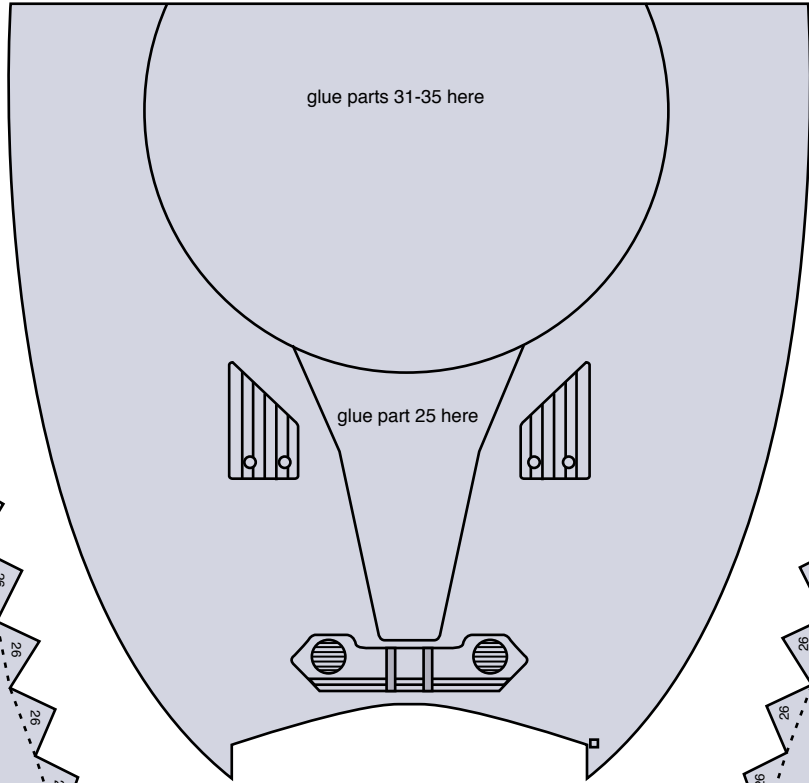

part 24b

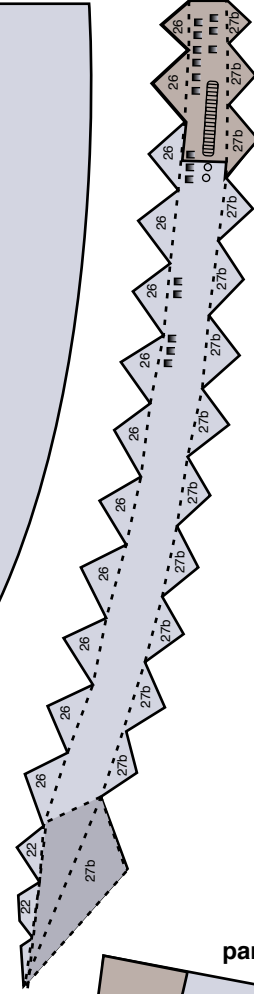

part 27a



part 27b



part 25

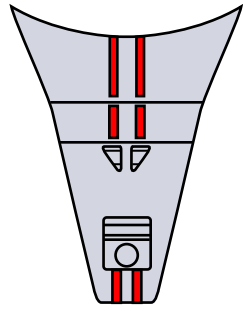

part 30a

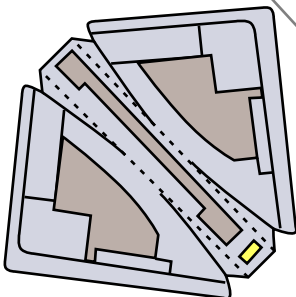

part 30b

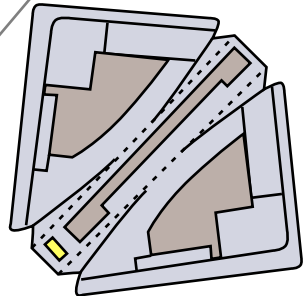

part 29

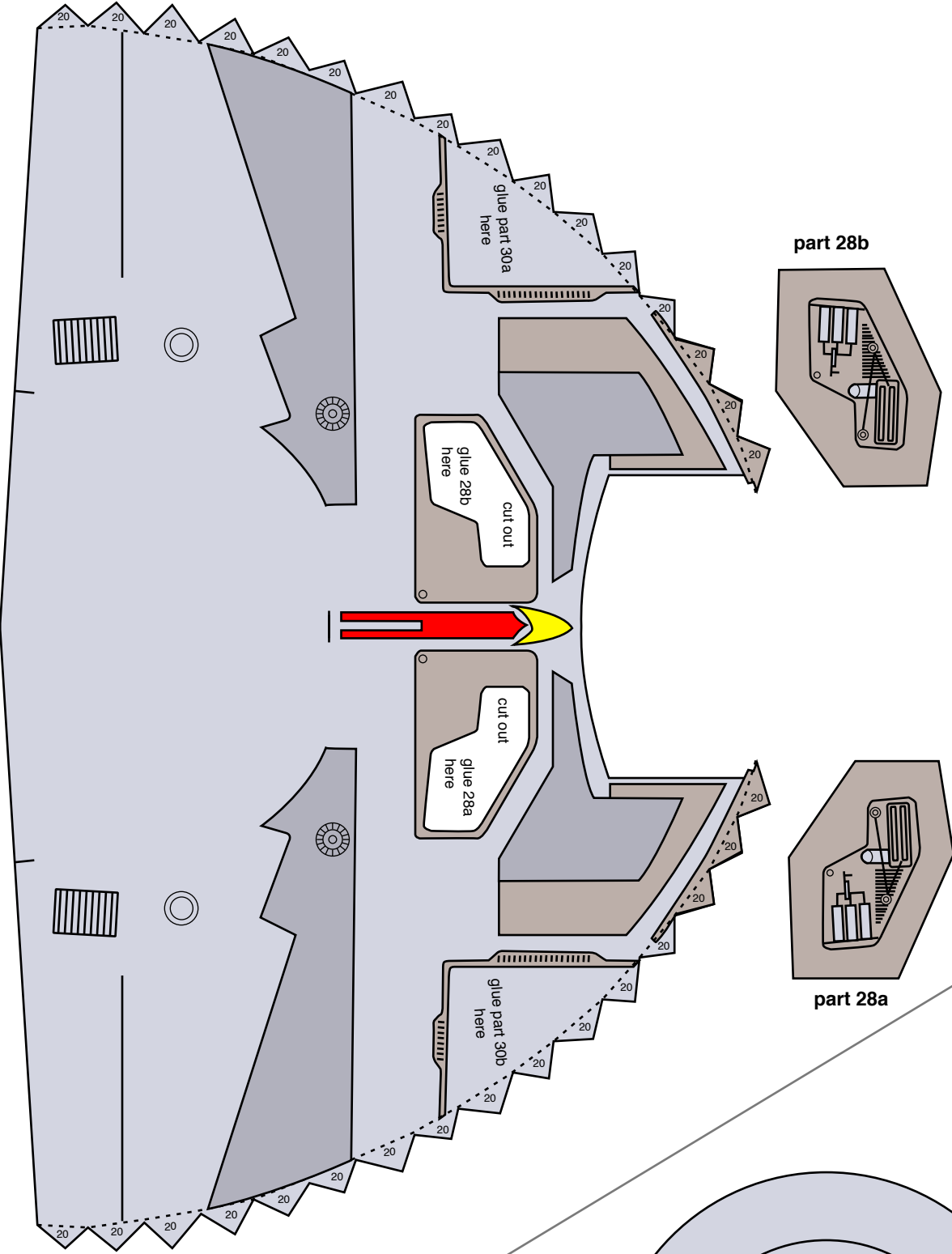

part 28b

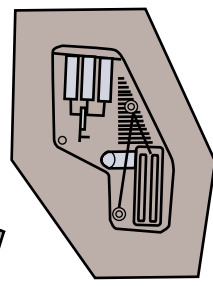

part 28a

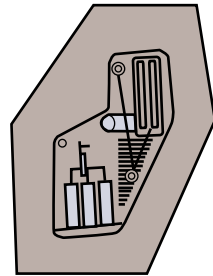

part 34

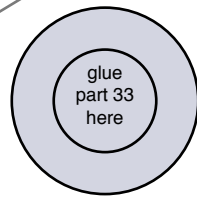

part 33

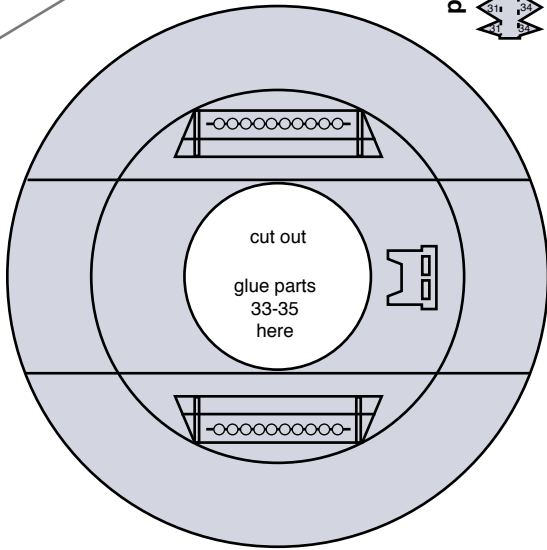

part 31

part 35

colored side IN!

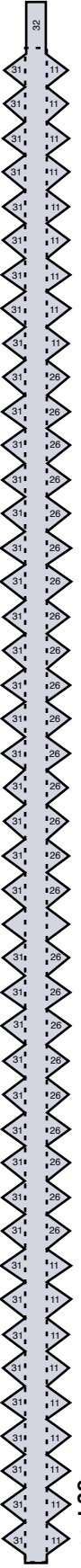
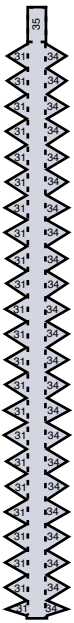

part 32

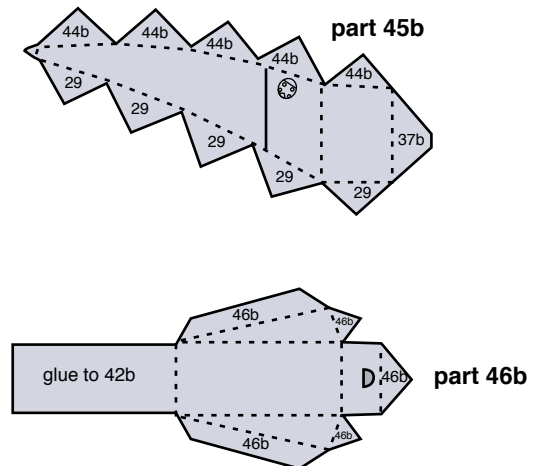
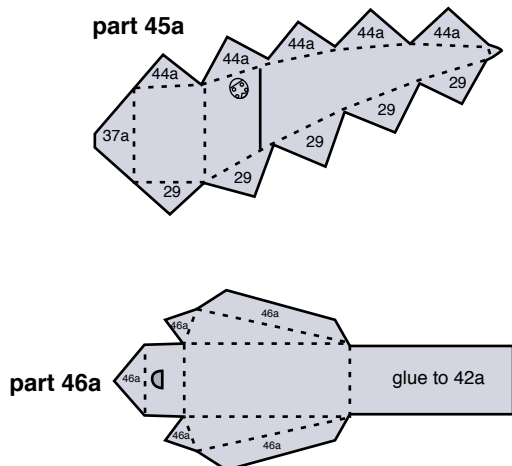
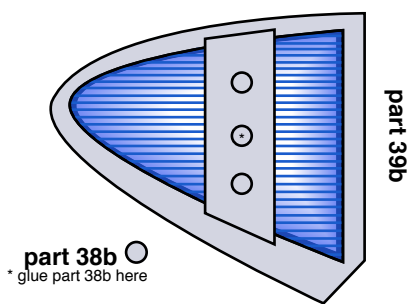
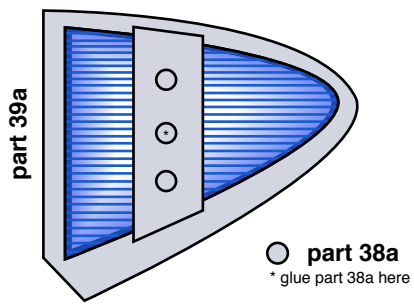
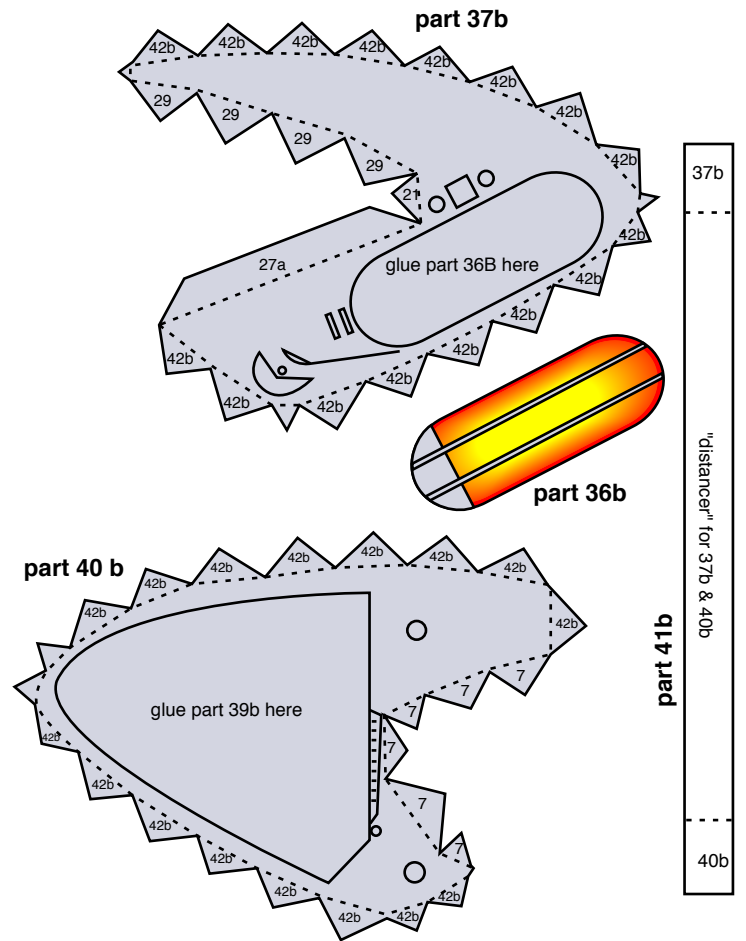
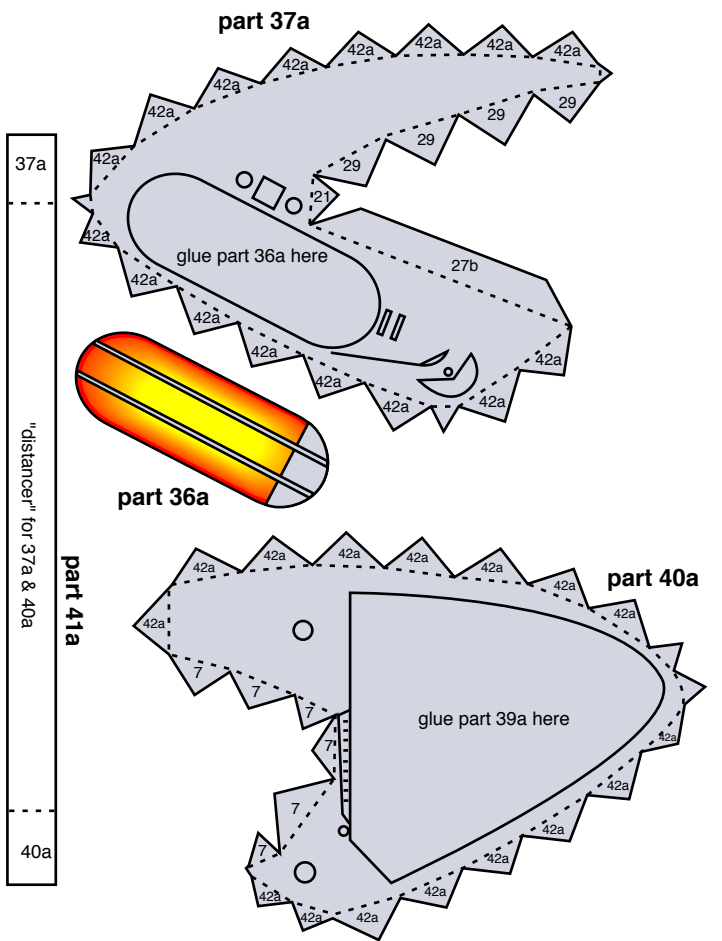

glue to back of 42a

part 44a

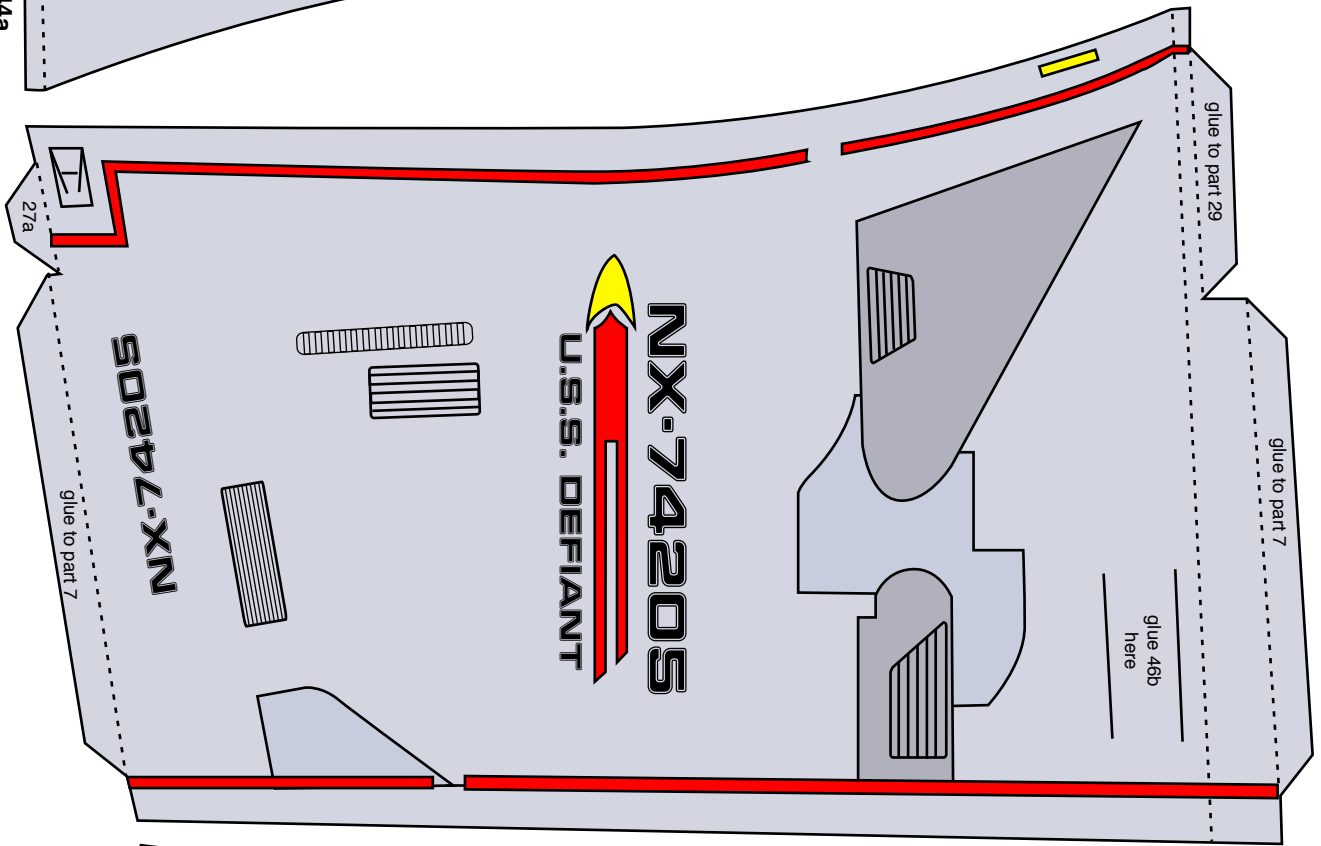

glue to back of 42a

part 43a

glue to back of 42b

part 43b

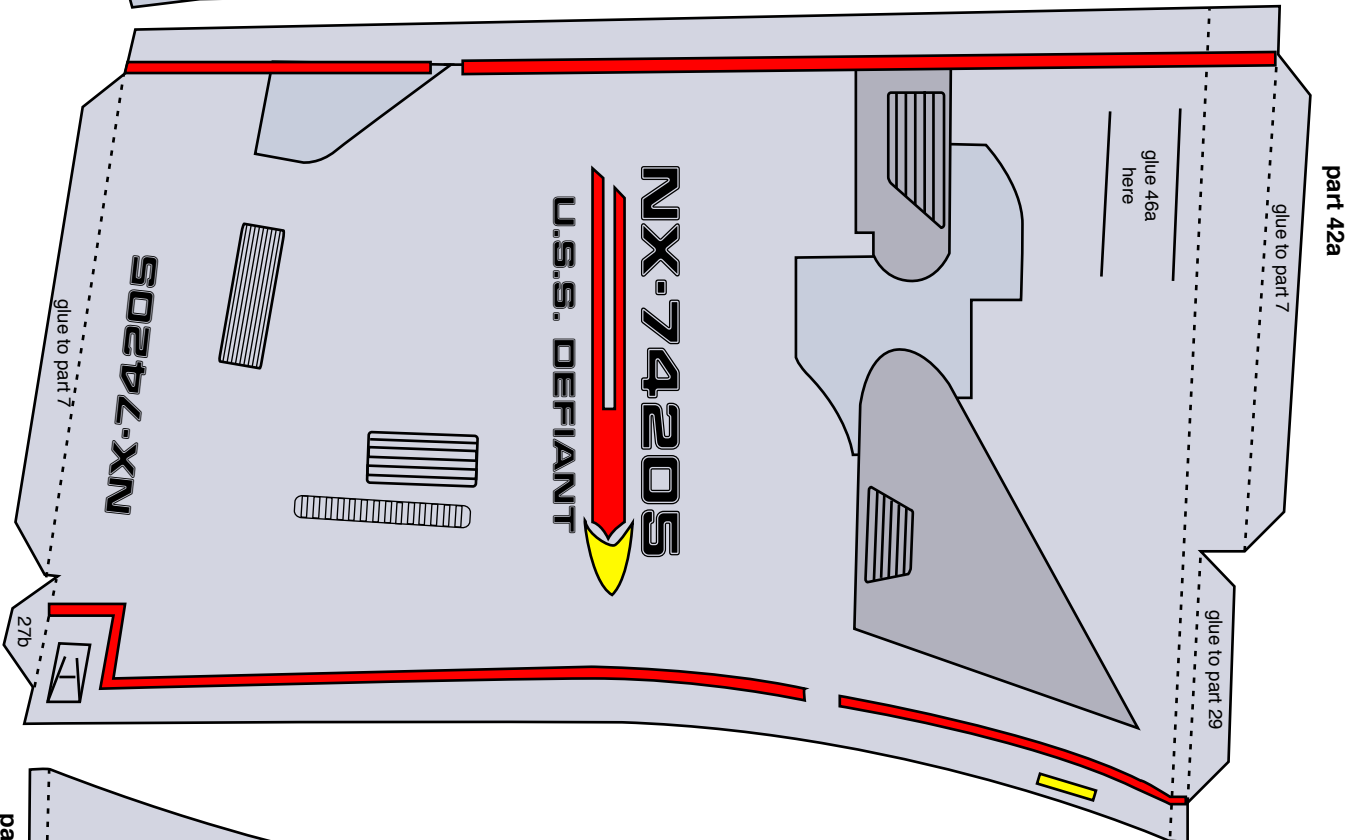

glue to back of 42b

part 44b

